

F - T H E T A L E N S

# f-65T-14-1030-1080

en | Data sheet | 1.0.1

- Telecentric fused silica lens
- Wavelength 1030 – 1080 nm
- Nominal focal length 65 mm
- Max. input beam diameter 14 mm
- Maximum working area 20 x 20 mm



Wavelength	1030 – 1080 nm	Mirror distance m1/m2	17 / 15.3 mm
Nominal focal length	65 mm	Anti-reflective coating	Standard
Effective focal length	65.000 mm	Telecentric error	1.7 °
Flange focal length	107.900 mm	Cooling method	Air
Max. input beam diameter	14 mm	Lens material	Fused silica
Working distance	55.900 mm	Mounting thread	M85x1
Max. scan field	20 x 20 mm	Lens diameter	90 mm
Minimum spot size	9,17 µm		

Information is subject to change without notice.  
Product photos are non-binding and may show customized features.



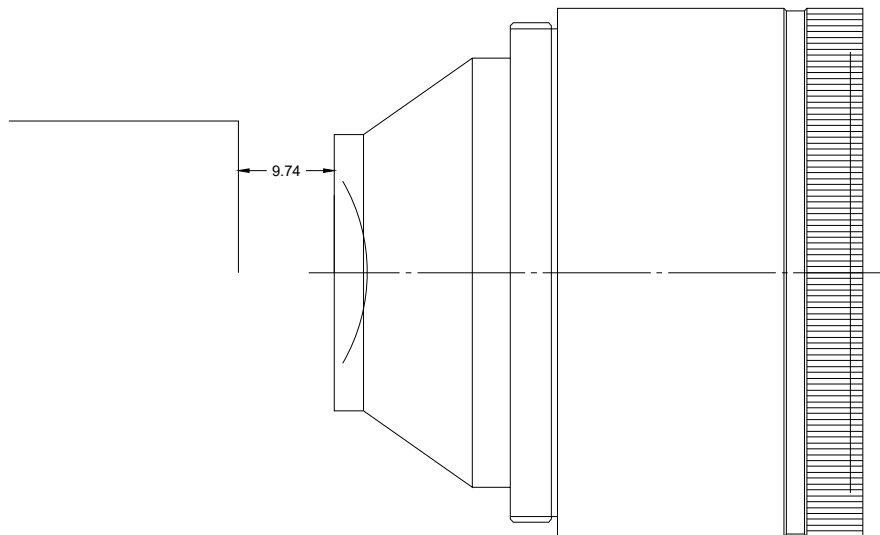
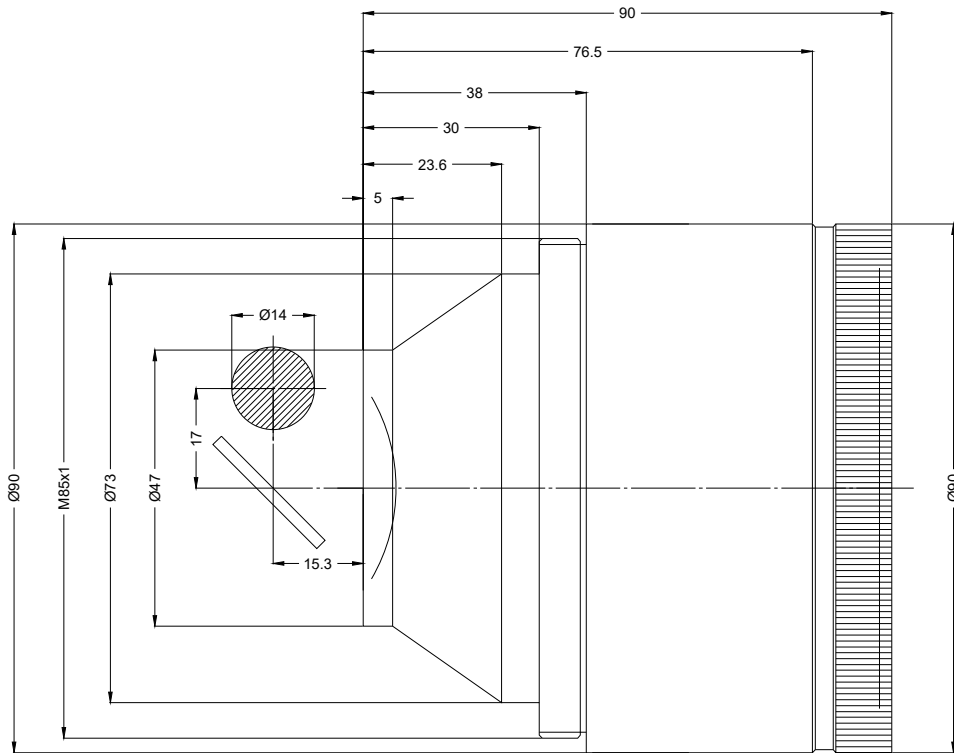

F-Theta lens

f-65T-14-1030-1080

Dimensions are given in millimeters and are intended as reference values.  
Binding information is available on request.

