

C W F I B E R L A S E R

CW-1500MM-L2

en | Data sheet | 1.0

- Compact, water-cooled design with a weight of only 11 kg
- Seamlessly integrable into systems with highly limited installation space
- Ideal for precision cutting and welding in compact systems



Wavelength	1080 nm
Nominal output power (CW)	1500 W
Laser operation mode	CW, modulated
Beam parameter product (BPP)	1.5 mm*mrad ^[1]
Fiber core diameter	50 µm ^[2]
Modulation frequency	1 Hz – 10 kHz
Power instability Ø	2%
Power tuning range	10 – 100%
Polarization	Random
Fiber length	5 m ^[3]

Cooling method	Water
Cooling flowrate	11 l/min
Cooling power	3 kW
Aiming beam	Standard
Output type	QBH
Supply voltage DC	110 V
Input current	40.9 A
Power consumption @ 20°C	4500 W
Operation temperature	10 – 40 °C
Storage temperature	-10 – 60 °C
Mechanical dimensions (W × D × H)	270 × 400 × 52 mm
Net weight	11 kg

Product customizations are possible on request.

^[1] Depending on fiber core diameter

^[2] Other available fiber core diameters: 100 µm

^[3] Other available fiber lengths: 3 m – 20 m



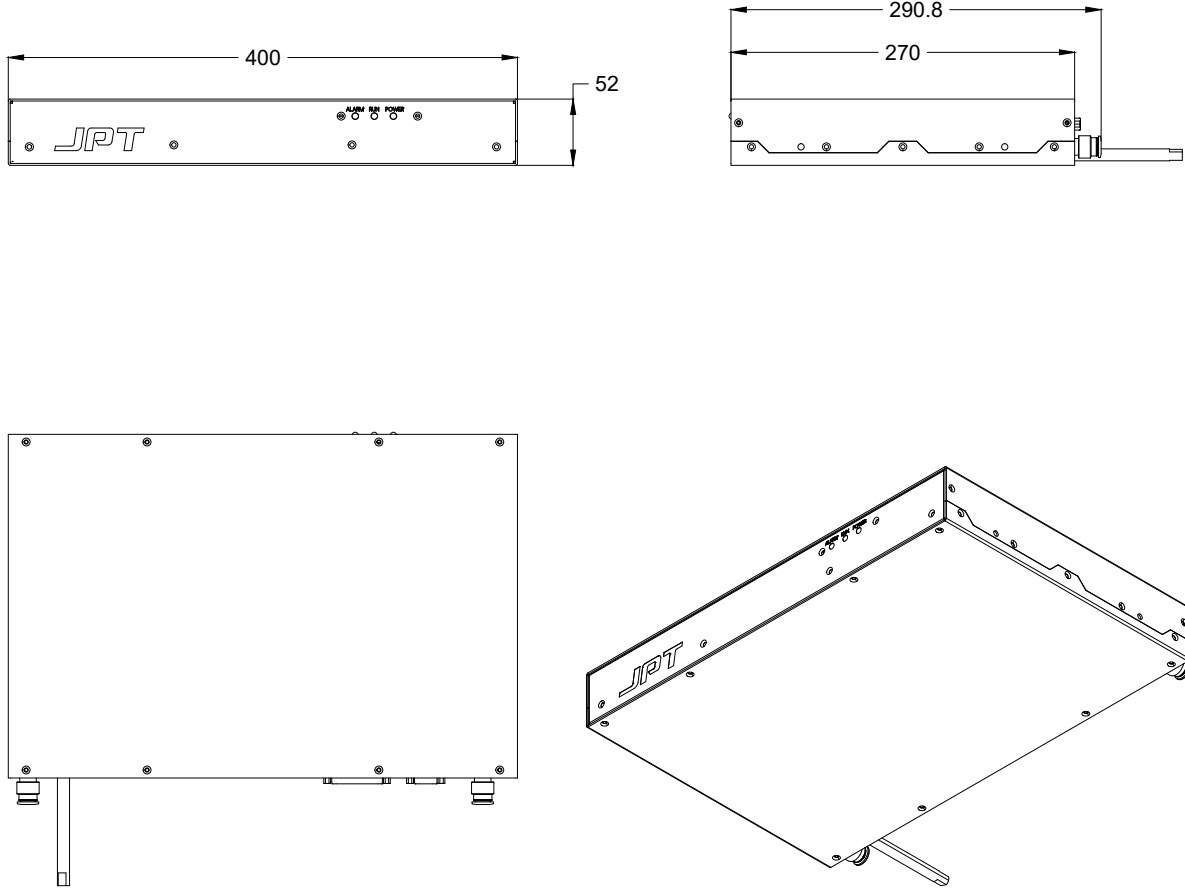

Laser product
Class 4

JPT

Manufacturer

CW fiber laser

CW-1500MM-L2

Dimensions are given in millimeters and are intended as reference values.
Binding information is available on request.

